



Met

mobili | Möbel | muebles

P 51 cm



Met: com'è realizzato

Met: wie es gemacht ist

Met: cómo está hecho

① LAVABI

Top con lavabo integrato disponibile in varie forme e materiali.

① WASCHBECKEN

Waschtischplatte mit integriertem Waschbecken erhältlich in verschiedenen Formen und Materialien.

① LAVABOS

Encimera con lavabo integrado disponible en varias formas y materiales.

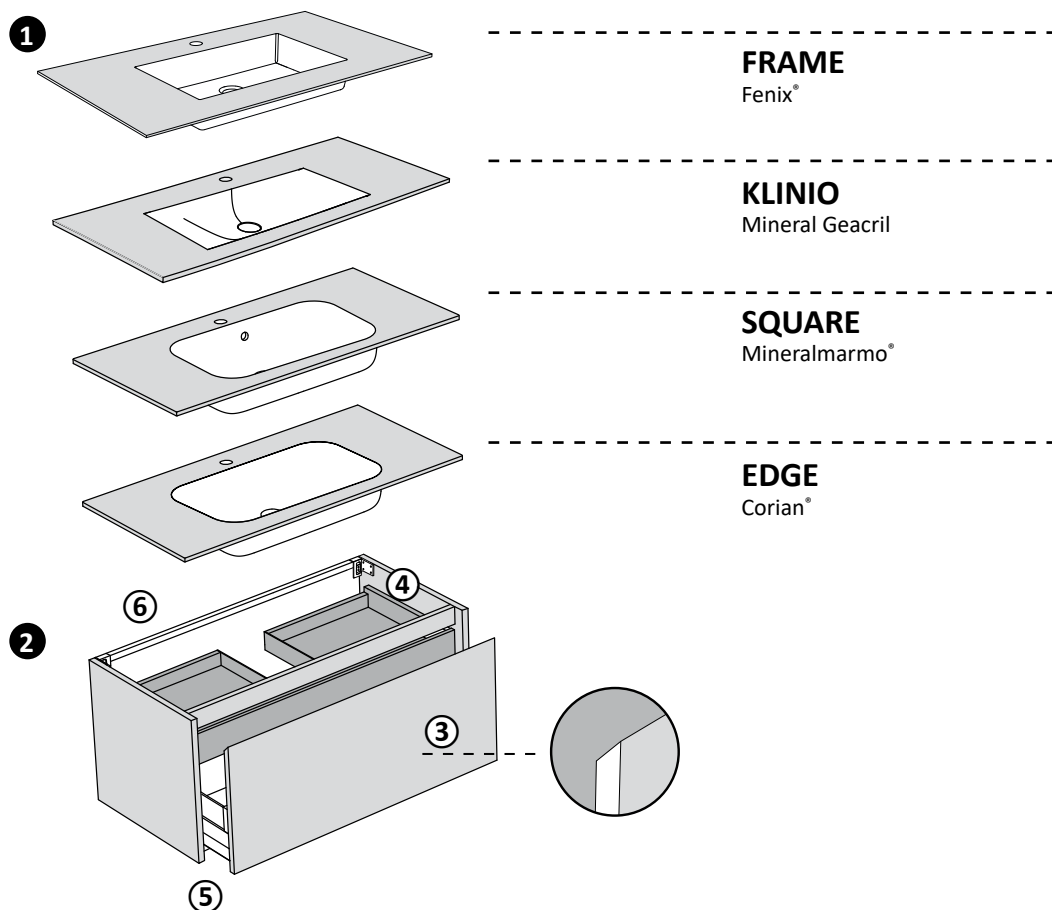

② MOBILE

Realizzato con differenti materiali, naturali o tecnologici.

Struttura realizzata con pannelli in melamminico Classe E1, W100 impiallacciato legno, oppure con pannelli MDF Classe E1 verniciati,

③ Frontali con apertura a gola sagomata con taglio a 45° realizzati in:

- Finiture laccate con pannello in MDF Classe E1
- Finiture legno con impiallacciatura di legno su pannello in multistrato di betulla o tristrato di rovere
- Finiture legno Jazz con impiallacciatura di legno su pannello in MDF Classe E1 colore nero

② MÖBEL

Hergestellt mit verschiedenen Materialien, sowohl natürlich als auch technologisch.

Struktur aus Melaminplatten E1-Klasse, W100 Holz furnierplatten oder aus lackierten E1-Klasse MDF-Platten.

③ Fronten mit geformter Griffmulde mit 45° -Schnitt, hergestellt aus:

- Lackierte Endfertigung mit MDF-Platten der Klasse E1
- Holzendfertigungen aus Holz furnier auf einer mehrschichtigen Birkenholzplatte oder Massivholz, dreischichtige Eiche
- Jazz-Holzausführung mit Holz furnier auf MDF-Platte Klasse E1 in schwarzer Farbe

② MUEBLES

Hecho con diferentes materiales, naturales o tecnológicos.

Estructura hecha con paneles de melamina Clase E1, de chapa de madera, W100, o con paneles de MDF pintados Clase E1.

③ Frentes con apertura a gola con corte de 45° hechos de:

- Acabados lacados con panel MDF Clase E1
- Acabados de madera con chapa de madera en un panel de madera multicapa de abedul o madera maciza, roble de tres capas
- Acabado de madera Jazz con chapa de madera sobre panel MDF clase E1 en color negro

Met: com'è realizzato

Met: wie es gemacht ist

Met: cómo está hecho

④ Struttura interna realizzata con pannelli in melaminico Classe E1, W100 colore grigio antracite

⑤ Cassetti in metallo verniciato e vetro, chiusura soft-system

⑥ Installazione a muro con attacchi a parete regolabili, barre strutturali in alluminio utilizzabili come sistema antisgancio.

④ Interne Struktur hergestellt aus Melaminplatten Klasse E1, W100 anthrazitgrau

⑤ Schubladen aus lackiertem Metall und Glas, Soft-Schließsystem

⑥ Wandmontage mit einstellbaren Wandhalterungen, Strukturstangen aus Aluminium, die als Anti-Release-System verwendet werden können.

④ Estructura interna hecha con paneles de melamina Clase E1, W100 gris antracita

⑤ Cajones en metal pintado y vidrio, sistema de cierre soft-system

⑥ Instalación de pared con soportes de pared ajustables, barras estructurales en aluminio que pueden usarse como sistema antidesbloqueo.

Lavorazioni su misura

Kundenspezifische Maßanfertigungen

Realizaciones hechas a medida

Mobili

- Per qualsiasi modifica richiedere fattibilità e preventivo all'ufficio commerciale all'indirizzo email commerciale@stocco.it.
- Colori Ral o a campione supplemento €368 di listino

Möbel

- Für alle Änderung fordern Sie die Durchführbarkeit und ein Angebot beim Verkaufsbüro an unter der E-Mail-Adresse commerciale@stocco.it.
- Ral- und Musterfarben Aufpreis von €368 Listenpreis

Muebles

- Para cualquier modificación solicite factibilidad y presupuesto a la oficina de ventas en la dirección commerciale@stocco.it.
- Colores Ral o de muestra suplemento de €368 de lista

Met: materiali e finiture

Met: Materialien und Endfertigungen

Met: materiales y acabados

STRUTTURA
KORPUS
ESTRUCTURA

CAT. O - LACCATO OPACO
CAT. B - LACCATO LUCIDO
CAT. RN - ROVERE NATURALE
CAT. OS - OLMO SMOKE
CAT. NT - NOCE TAN
CAT. WN - WALNUT NATURALE
CAT. AF - FENIX
CAT. BF - FENIX COLORATO

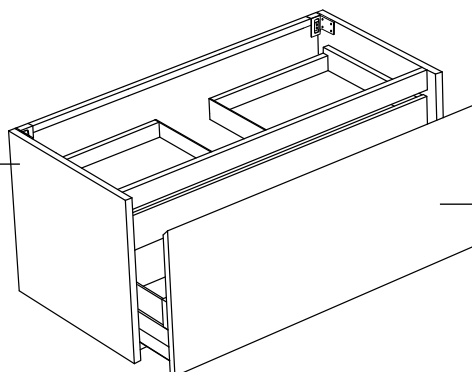

FRONTALE
FRONT
FRONTAL

CAT. O - LACCATO OPACO
CAT. B - LACCATO LUCIDO
CAT. RN - ROVERE NATURALE
CAT. OS - OLMO SMOKE
CAT. NT - NOCE TAN
CAT. JWN - WALNUT NATURALE JAZZ
CAT. JRN - ROVERE NATURALE JAZZ
CAT. LV2 - ROVERE VINTAGE SPACCO NERO
CAT. W5 - ROVERE TERMO-TRATTATO
CAT. AF - FENIX
CAT. BF - FENIX COLORATO

Attenzione: il legno è un prodotto naturale; pertanto l'azienda non può garantire la corrispondenza con i campioni. Qualsiasi variazione del colore, venatura o effetto del legno deve considerarsi non contestabile, rappresentando pregio del materiale e delle lavorazioni artigianali.

Achtung: Holz ist ein Naturprodukt, deshalb kann das Unternehmen nicht die Übereinstimmung mit den Mustern garantieren. Jede Abweichung in der Farbe, Maserung oder im Effekt des Holzes muss als nicht beanstandbar angesehen werden, da es ein Zeichen des Werts des Materials und der handwerklichen Verarbeitung darstellt.

Atención: la madera es un producto natural; por tanto la empresa no puede garantizar la correspondencia con las muestras. Todas variaciones del color, venas o efectos de la madera no pueden ser cuestionados, ya que representan el valor del material y de los trabajos artesanales.

Struttura: materiali e finiture

Korpus: Materialien und Endfertigungen

Estructura: materiales y acabados

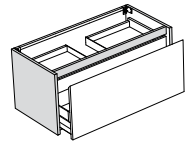

LACCATO / LACKIERT / LACADO

CAT. O - Laccato opaco / Matt lackiert / Lacado mate

CAT. B - Laccato lucido / Glänzend lackiert / Lacado brillante

PoppingTrend



O. 283 - B. 282
Salice



O. 281 - B. 280
Savana



O. 36 - B. 113
Bordeaux



O. 285 - B. 284
Oriente



O. 287 - B. 286
Oceano



O. 190 - B. 189
Oltremare

FeelingSoft



O. 182 - B. 181
Salvia



O. 271 - B. 270
Tahiti



O. 273 - B. 272
Santorini



O. 275 - B. 274
Lavanda



O. 277 - B. 276
Lilla



O. 279 - B. 278
Pesca

ForeverChic



O. 20 - B. 21
Bianco

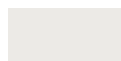

O. 231 - B. 230
Perla



O. 233 - B. 232
Seta

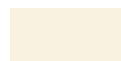

O. 235 - B. 234
Alpaca



O. 172 - B. 171
Lino



O. 180 - B. 179
Avana



O. 237 - B. 236
Argilla

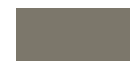

O. 174 - B. 173
Corda



O. 239 - B. 238
Pietra



O. 241 - B. 240
Cervino



O. 243 - B. 242
Dolomiti



O. 245 - B. 244
Arizona



O. 247 - B. 246
Cipria



O. 249 - B. 248
Erica



O. 251 - B. 250
Terra



O. 253 - B. 252
Granata



O. 255 - B. 254
Bosco



O. 257 - B. 256
Oliva



O. 259 - B. 258
Canapa



O. 261 - B. 260
Cotone



O. 263 - B. 262
Efeso



O. 265 - B. 264
Lavaredo



O. 267 - B. 266
Pamir



O. 269 - B. 268
Bromo



O. 198 - B. 104
Grafite



O. 46 - B. 100
Nero

FenixLike



O. 289 - B. 288
Ottawa



O. 291 - B. 290
Londra



O. 263 - B. 262
Efeso



O. 269 - B. 268
Bromo



O. 295 - B. 294
Jaipur



O. 297 - B. 296
Orinoco



O. 293 - B. 292
Fes

Struttura: materiali e finiture

Korpus: Materialien und Endfertigungen

Estructura: materiales y acabados

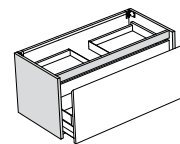

LEGNO / HOLZ / MADERA

Venatura verticale / Senkrechte Maserung / Grano vertical



CAT. RN

Legno Rovere naturale



CAT. OS

Legno Olmo Smoke



CAT. NT

Legno Noce Tan



CAT. WN

Legno Walnut naturale

FENIX®

CAT. AF - FENIX

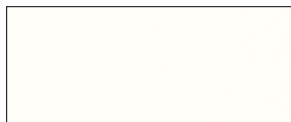

FX32

Bianco Kos

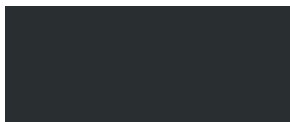

FX720

Nero Ingo

CAT. BF - FENIX COLORATO



FX717

Castoro Ottawa



FX718

Grigio Londra



FX725

Grigio Efeso



FX724

Grigio Bromo



FX751

Rosso Jaipur



FX749

Cacao Orinoco



FX754

Blu Fes

Frontali: materiali e finiture

Fronten: Materialien und Endfertigungen

Frontales: materiales y acabados

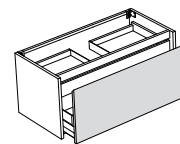

LACCATO / LACKIERT / LACADO

CAT. O - Laccato opaco / Matt lackiert / Lacado mate

CAT. B - Laccato lucido / Glänzend lackiert / Lacado brillante

PoppingTrend

O. 283 - B. 282 Salice	O. 281 - B. 280 Savana	O. 36 - B. 113 Bordeaux	O. 285 - B. 284 Oriente	O. 287 - B. 286 Oceano	O. 190 - B. 189 Oltremare

FeelingSoft

O. 182 - B. 181 Salvia	O. 271 - B. 270 Tahiti	O. 273 - B. 272 Santorini	O. 275 - B. 274 Lavanda	O. 277 - B. 276 Lilla	O. 279 - B. 278 Pesca

ForeverChic

O. 20 - B. 21 Bianco	O. 231 - B. 230 Perla	O. 233 - B. 232 Seta	O. 235 - B. 234 Alpaca	O. 172 - B. 171 Lino	O. 180 - B. 179 Avana	O. 237 - B. 236 Argilla	O. 174 - B. 173 Corda
O. 239 - B. 238 Pietra	O. 241 - B. 240 Cervino	O. 243 - B. 242 Dolomiti	O. 245 - B. 244 Arizona	O. 247 - B. 246 Cipria	O. 249 - B. 248 Erica	O. 251 - B. 250 Terra	O. 253 - B. 252 Granata
O. 255 - B. 254 Bosco	O. 257 - B. 256 Oliva	O. 259 - B. 258 Canapa	O. 261 - B. 260 Cotone	O. 263 - B. 262 Efeso	O. 265 - B. 264 Lavaredo	O. 267 - B. 266 Pamir	O. 269 - B. 268 Bromo
O. 198 - B. 104 Grafite	O. 46 - B. 100 Nero						

FenixLike

O. 289 - B. 288 Ottawa	O. 291 - B. 290 Londra	O. 263 - B. 262 Efeso	O. 269 - B. 268 Bromo	O. 295 - B. 294 Jaipur	O. 297 - B. 296 Orinoco	O. 293 - B. 292 Fes

Frontali: materiali e finiture

Fronten: Materialien und Endfertigungen

Frontales: materiales y acabados

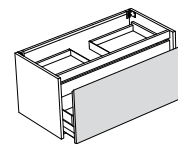

LEGNO JAZZ / HOLZ JAZZ / MADERA JAZZ

Venatura verticale / Senkrechte Maserung / Grano vertical

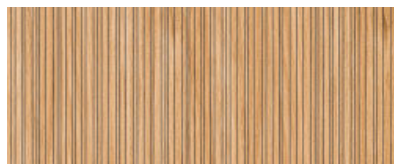

CAT. JRN

Legno Rovere naturale Jazz

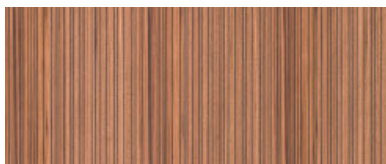

CAT. JWN

Legno Walnut Jazz

LEGNO / HOLZ / MADERA

Venatura verticale / Senkrechte Maserung / Grano vertical



CAT. OS

Legno Olmo Smoke



CAT. NT

Legno Noce Tan

Venatura orizzontale / Waagerechte Maserung / Grano horizontal

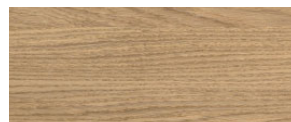

CAT. RN

Legno Rovere naturale



CAT. LV2

Legno Rovere Vintage
con spacco nero



CAT. W5

Legno Rovere
termo-trattato

Frontali: materiali e finiture

Fronten: Materialien und Endfertigungen

Frontales: materiales y acabados

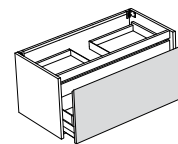

FENIX®

CAT. AF - FENIX

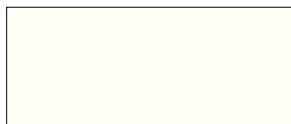

FX32
Bianco Kos



FX720
Nero Ingo

CAT. BF - FENIX COLORATO



FX717
Castoro Ottawa



FX718
Grigio Londra



FX725
Grigio Efeso



FX724
Grigio Bromo



FX751
Rosso Jaipur



FX749
Cacao Orinoco



FX754
Blu Fes

Met: panoramica prodotti

Met: Produktübersicht

Met: visión general del producto

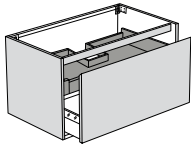

H.48

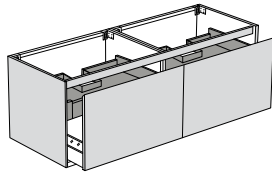

H.48

L.70		
L.90		
L.100		
L.120	 	
L.140		
L.160		
L.180		