

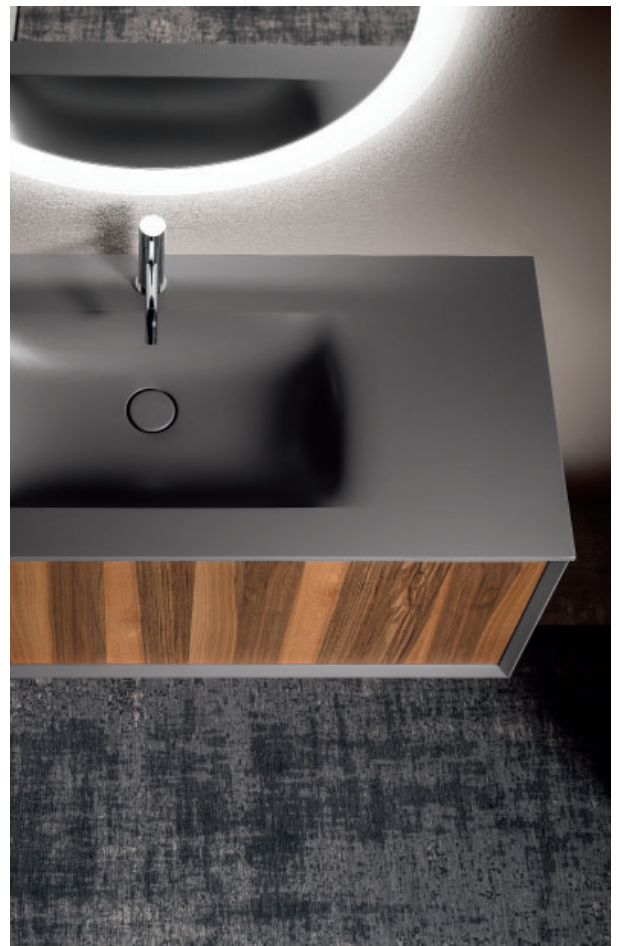

Iks up

meubles | meubels | base units

P 51,5 cm



Iks up : en détail

Iks up: hoe wordt het gemaakt

Iks up: how it is made

① VASQUES

Plan vasque avec vasque moulée et à poser ou semi-encastrée, disponible en différentes formes et matériaux.

① WASTAFELS

Wastafelblad met ofwel een geïntegreerde wastafel, een bovenop staande wastafel ofwel een half-ingebouwde wastafel, verkrijgbaar in verschillende vormen en materialen.

① WASHBASINS

Top with integrated washbasin and sit-on or semi-recessed washbasin, available in various shapes and materials.

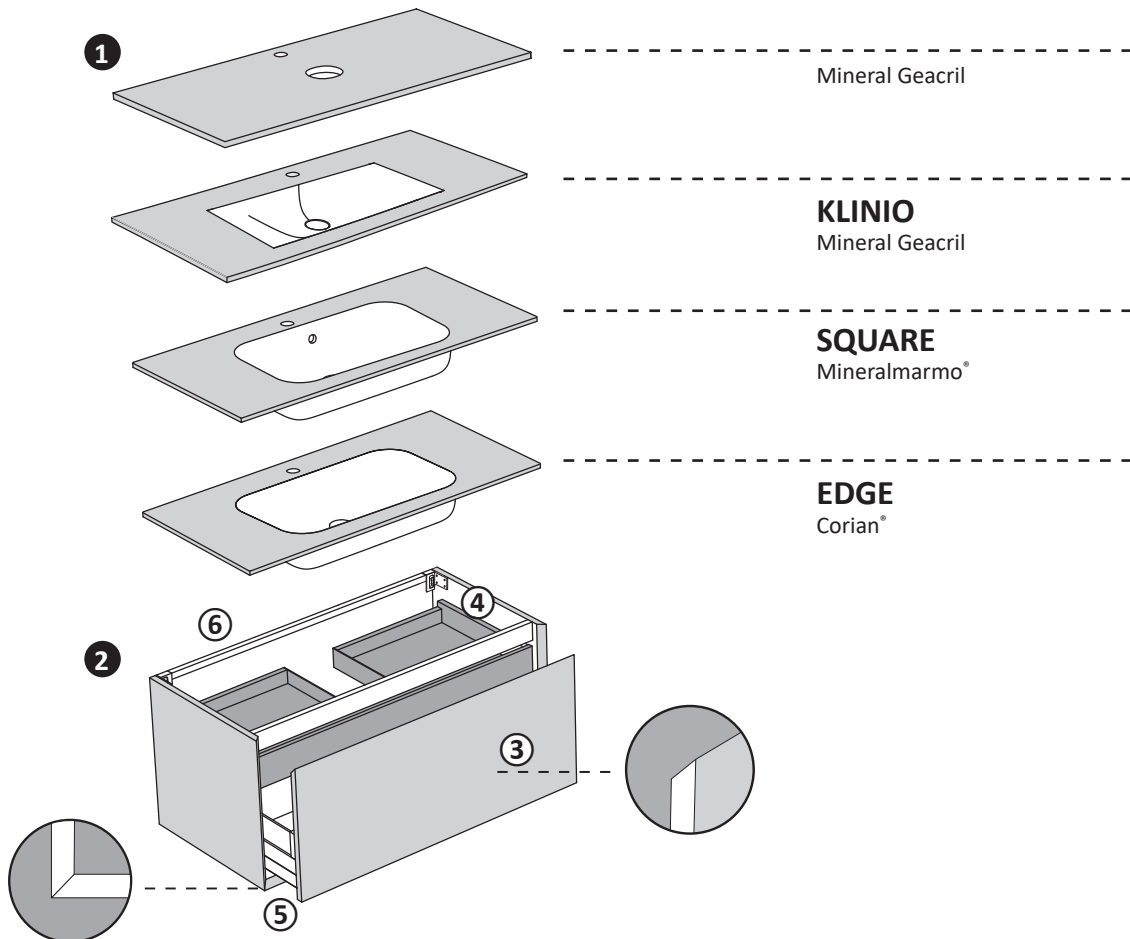

② MEUBLE

Réalisé avec différents matériaux, naturels ou technologiques est jointé à 45° sur les deux coins inférieurs. Caisson réalisé avec panneaux MDF Classe E1, W100 placage de bois, ou avec panneaux MDF de Classe E1 vernis.

③ Façades avec ouverture à gorge avec coupe à 45° en :

- Finitions laquées avec panneau MDF Classe E1
- Finitions bois avec placage de bois sur un panneau de contreplaqué de bouleau ou chêne à trois couches
- Finition grès FG, céramique laminée sur panneau mélaminé Classe E1

② KAST

Van verschillende natuurlijke of technische materialen, 45° verbinding op de twee hoeken onderaan. Structuur met MDF-panels klasse E1, W100 houtfineer of gelakte MDF-panels klasse E1.

③ Frontelementen met verzonken 45° profielgreep:

- Gelakte afwerkingen met MDF-paneel klasse E1
- Houtfineer op berken multiplex of eiken triplex
- Afwerking FG-grès, keramisch laminaat op MDF-paneel klasse E1

② BASE UNIT

Made of different materials, natural or technological, it is jointed at 45° on the two lower corners.

Structure realized with MDF Class E1, W100 wood veneer panels, or with painted E1 Class MDF panels.

③ Fronts with shaped groove opening with 45° cut made of:

- Lacquered finishes with MDF panel Class E1
- Wood finishes with wood veneer on a multilayered birchwood panel or three-layer oak
- Finish grès FG, laminated ceramic on melamine panel Class E1

Iks up : en détail

Iks up: hoe wordt het gemaakt

Iks up: how it is made

④ Structure interne réalisée avec panneaux de mélamine Classe E1, W100 gris anthracite

⑤ Tiroirs en métal verni et verre, système de fermeture soft-system

⑥ Installation murale avec supports muraux réglables, barres structurelles en aluminium qui peuvent être utilisées comme système anti-dégagement.

④ Binnenstructuur uitgevoerd met melamine-panelen in Klasse E1, W100 kleur antracietgrijs

⑤ legplanken in gevernist metaal en glas, gedempt sluitsysteem

⑥ Installatie in de muur met regelbare wandaansluitingen, structurele stangen in aluminium die als extra ophangbeveiliging kunnen dienen.

④ Internal structure made with melamine panels Class E1, W100 anthracite gray

⑤ Drawers in painted metal and glass, soft-closing system

⑥ Wall installation with adjustable wall brackets, structural bars in aluminium that can be used as an anti-release system.

Réalisations sur mesure

Op maat gemaakte bewerkingen

Made-to-measure

Meubles

- Pour toute modification demander la faisabilité et les devis au bureau commercial à l'adresse email commerciale@stocco.it.
- Couleurs RAL ou à échantillon : supplément de €350 prix public

Meubels

- Voor iedere aanpassing moet de uitvoerbaarheid en de prijs ervan bij de commerciële dienst nagevraagd worden op het e-mailadres commerciale@stocco.it.
- Ral-kleuren ofwel per kleurstaal meerprijs van €350

Base units

- For every modification request feasibility and offer to the sales office at the email address commerciale@stocco.it.
- Ral or sample colors supplement of €350 list price

Iks up : matériaux et finitions

Iks up: materialen en afwerkingen

Iks up: materials and finishes

CAISSON
STRUCTUUR
STRUCTURE

CAT. OW - LACCATO BIANCO OPACO
CAT. RN - ROVERE NATURALE
CAT. O - LACCATO COLORATO OPACO

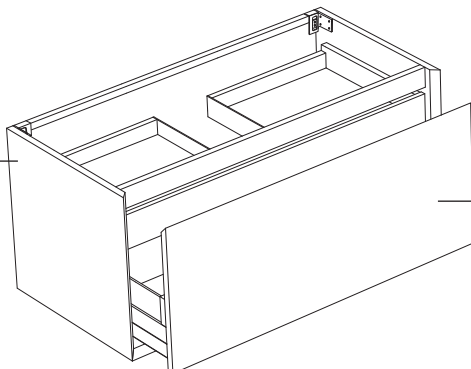

FAÇADE
VOORZIJDEN
FRONT

CAT. RN - ROVERE NATURALE
CAT. LV2 - ROVERE VINTAGE SPACCO NERO
CAT. W5 - ROVERE TERMO-TRATTATO
CAT. NT - NOCE TAN
CAT. OS - OLMO SMOKE
CAT. O - LACCATO OPACO
CAT. B - LACCATO LUCIDO
CAT. FG - GRES

Attention : le bois est un produit naturel; pourtant ce n'est pas possible de garantir la correspondance aux échantillons. Les variations de la couleur, veines ou effet du bois ne peuvent pas être contestées : elles représentent la valeur du matériel et des travaux artisanales.

Opgepast: hout is een natuurlijk product, om die reden kan het bedrijf niet exact hetzelfde resultaat als dat van de monsters garanderen. Iedere afwijking in kleur, nerven of een ander effect in het hout kan niet het onderwerp van een klacht uitmaken, gezien het een kenmerk is, dat eigen is aan het materiaal en aan de ambachtelijke behandelingen.

Attention: wood is a natural product; therefore the company can not guarantee correspondence with the samples. Any variation of the color, grain or effect of the wood must be considered not contestable, representing the value of the material and of the craftsmanship.

Caisson : matériaux et finitions

Structuur: materialen en afwerkingen

Structure: materials and finishes

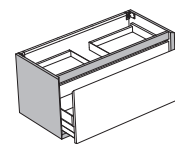

LAQUÉ / GELAKT / LACQUERED



CAT. OW

Laccato Bianco opaco

CAT. O - Laqué mat / Mat gelakt / Matt lacquered

PoppingTrend



O. 283
Salice



O. 281
Savana



O. 36
Bordeaux



O. 285
Oriente



O. 287
Oceano



O. 190
Oltremare

FeelingSoft



O. 182
Salvia



O. 271
Tahiti



O. 273
Santorini



O. 275
Lavanda



O. 277
Lilla



O. 279
Pesca

ForeverChic



O. 20
Bianco



O. 231
Perla



O. 233
Seta

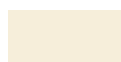

O. 235
Alpaca



O. 172
Lino



O. 180
Avana



O. 237
Argilla



O. 174
Corda



O. 239
Pietra



O. 241
Cervino



O. 243
Dolomiti



O. 245
Arizona



O. 247
Cipria



O. 249
Erica



O. 251
Terra



O. 253
Granata



O. 255
Bosco



O. 257
Oliva



O. 259
Canapa



O. 261
Cotone



O. 263
Efeso



O. 265
Lavaredo



O. 267
Pamir



O. 269
Bromo



O. 198
Grafite



O. 46
Nero

FenixLike



O. 289
Ottawa



O. 291
Londra



O. 263
Efeso



O. 269
Bromo



O. 295
Jaipur



O. 297
Orinoco



O. 293
Fes

BOIS / HOUT / WOOD



CAT. RN

Legno Rovere naturale

Façades : matériaux et finitions

Voorzijden: materialen en afwerkingen

Fronts: materials and finishes

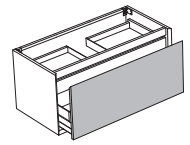

LAQUÉ / GELAKT / LACQUERED

CAT. O - Laqué mat / Mat gelakt / Matt lacquered

CAT. B - Laqué brillant / Glanzend gelakt / Glossy lacquered

PoppingTrend



O. 283 - B. 282
Salice



O. 281 - B. 280
Savana



O. 36 - B. 113
Bordeaux



O. 285 - B. 284
Oriente



O. 287 - B. 286
Oceano



O. 190 - B. 189
Oltremare

FeelingSoft



O. 182 - B. 181
Salvia



O. 271 - B. 270
Tahiti



O. 273 - B. 272
Santorini



O. 275 - B. 274
Lavanda



O. 277 - B. 276
Lilla



O. 279 - B. 278
Pesca

ForeverChic



O. 20 - B. 21
Bianco

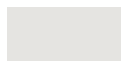

O. 231 - B. 230
Perla



O. 233 - B. 232
Seta

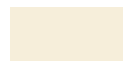

O. 235 - B. 234
Alpaca



O. 172 - B. 171
Lino



O. 180 - B. 179
Avana



O. 237 - B. 236
Argilla



O. 174 - B. 173
Corda



O. 239 - B. 238
Pietra



O. 241 - B. 240
Cervino



O. 243 - B. 242
Dolomiti



O. 245 - B. 244
Arizona



O. 247 - B. 246
Cipria



O. 249 - B. 248
Erica



O. 251 - B. 250
Terra



O. 253 - B. 252
Granata



O. 255 - B. 254
Bosco



O. 257 - B. 256
Oliva



O. 259 - B. 258
Canapa



O. 261 - B. 260
Cotone



O. 263 - B. 262
Efeso



O. 265 - B. 264
Lavaredo



O. 267 - B. 266
Pamir



O. 269 - B. 268
Bromo



O. 198 - B. 104
Grafite



O. 46 - B. 100
Nero

FenixLike



O. 289 - B. 288
Ottawa



O. 291 - B. 290
Londra



O. 263 - B. 262
Efeso



O. 269 - B. 268
Bromo



O. 295 - B. 294
Jaipur



O. 297 - B. 296
Orinoco



O. 293 - B. 292
Fes

BOIS / HOUT / WOOD

Veinage horizontal / Horizontale nerf / Horizontal grain



CAT. RN

Legno Rovere naturale



CAT. LV2

Legno Rovere Vintage
con spacco nero



CAT. W5

Legno Rovere
termo-trattato

Veinage vertical / Verticale nerf / Vertical grain



CAT. OS

Legno Olmo Smoke



CAT. NT

Legno Noce Tan

Façades : matériaux et finitions

Voorzijden: materialen en afwerkingen

Fronts: materials and finishes

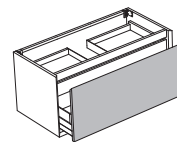

GRES

CAT. FG

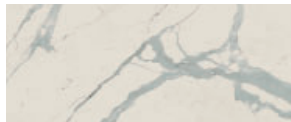

Gres mat / Gres mat / Gres matt

FG01

Bianco Statuario Venato
opaco



FG03

Oro Venato opaco



FG05

Nero Marquina opaco

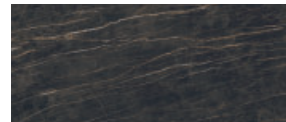

FG07

Noir Desir opaco

Gres brillant / Gres glanzend / Gres glossy

FG02

Bianco Statuario Venato
lucidato

FG04

Oro Venato lucidato

FG06

Nero Marquina lucidato











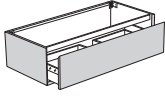
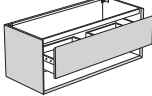
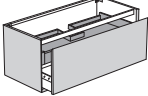
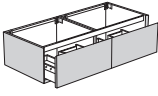
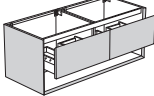
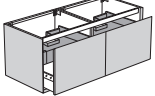















































FG08

Noir Desir lucidato

Iks up : vue d'ensemble de la collection

Iks up: overzicht produkten

Iks up: product overview

						
	H.34	H.50	H.50	H.34	H.50	H.50
L.70						
L.90						
L.100						
L.120	   	   	   	  	  	  
L.140				  	  	  
L.160				  	  	  
L.180				  	  	  



Iks full Frame

meubles | meubels | base units

P 53 cm

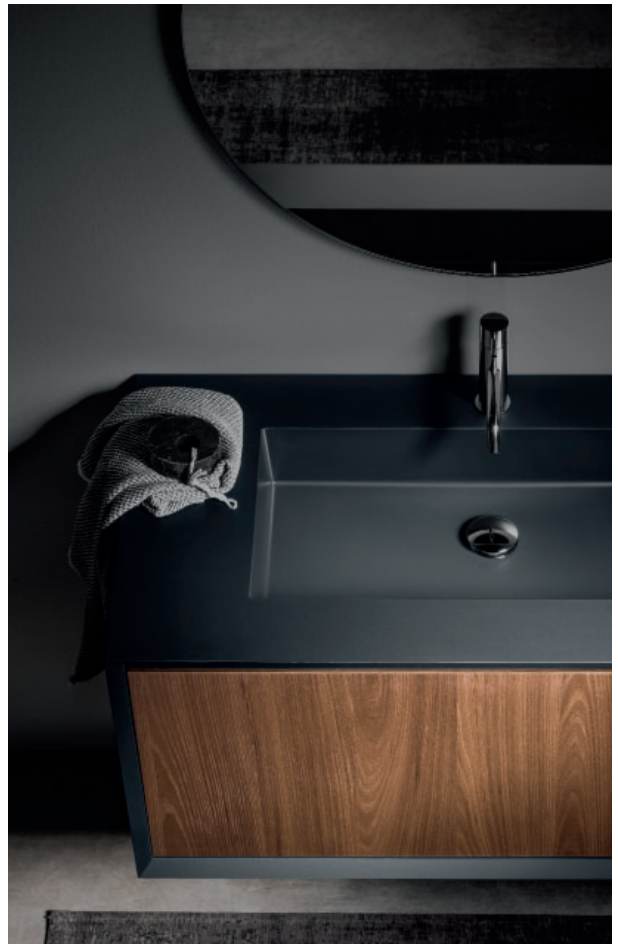

Iks full Frame : en détail

Iks full Frame: hoe wordt het gemaakt

Iks full Frame: how it is made

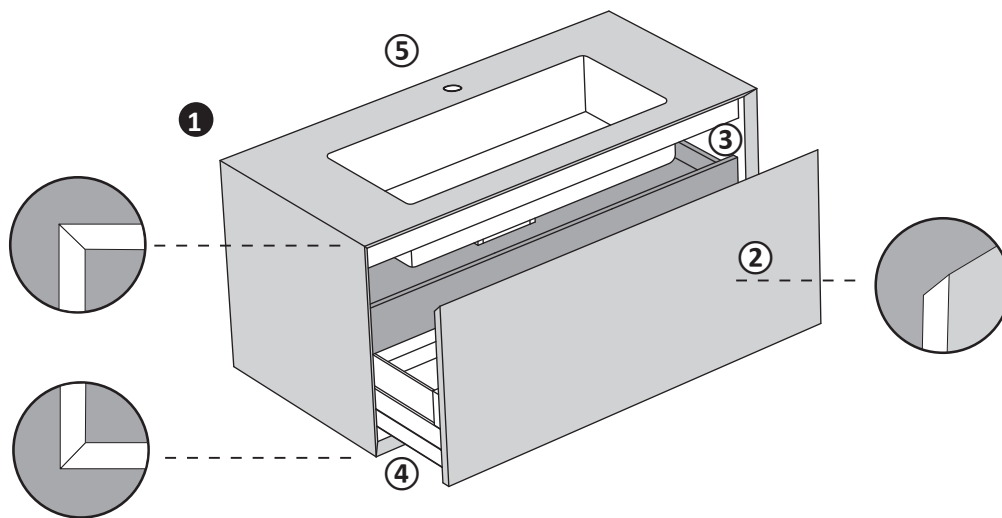

① MEUBLE

Réalisé avec différents matériaux, naturels ou technologiques est jointé à 45° sur les 4 coins.

Caisson réalisé avec panneaux de mélamine Classe E1, W100 Fenix®, avec vasque moulée

② Façades avec ouverture a gorge avec coupe à 45°, en :

- Finitions laquées avec panneau MDF Classe E1
- Finitions bois en placage de bois sur un panneau de contreplaqué de bouleau ou chêne à trois couches
- Finition Grès FG, céramique laminée sur panneau mélaminé Classe E1

③ Caisson interne réalisée avec panneaux de mélamine Classe E1, W100 gris anthracite

④ Tiroirs en métal verni et verre, système de fermeture soft-system

⑤ Installation murale avec supports muraux réglables, barres structurelles en aluminium équipées d'un système anti-dégagement.

① KAST

Van verschillende natuurlijke of technische materialen, 45° verbindingen op de vier hoeken.

Structuur van panelen met melaminelaag klasse E1, W100 Fenix® met ingebouwde wastafel

② Frontelementen met verzonken 45° profielgreep:

- Gelakte afwerkingen met MDF-paneel klasse E1
- Houtfineer op berken multiplex of eiken triplex
- Afwerking FG-grès, keramisch laminaat op MDF-paneel klasse E1

③ Inwendige structuur van panelen met melaminelaag klasse E1, antracietgrijs W100

④ Gelakte laden van metaal en glas, met zachteluiting

⑤ Bevestiging aan de wand met verstelbaar wandbeslag en aluminium wandrails met kantelbeveiliging.

① BASE UNIT

Made of different materials, natural or technological, it is jointed at 45° on the four corners.

Structure made of melamine Class E1, W100 Fenix® panels, with integrated washbasin.

② Fronts with shaped groove opening with 45° cut, made of:

- Lacquered finishes with MDF panel Class E1
- Wood finishes, wood veneer on a multilayered birchwood panel or three-layer oak
- Finish Gres FG, laminated ceramic on melamine panel Class E1

③ Internal structure made with melamine panels Class E1, W100 anthracite gray

④ Drawers in painted metal and glass, soft-closing system

⑤ Wall installation with adjustable wall brackets, structural bars in aluminium equipped with an anti-release system.

Réalisations sur mesure

Op maat gemaakte bewerkingen

Made-to-measure

Meubles et vasques

- Pour toute modification demander la faisabilité et les devis au bureau commercial à l'adresse email commerciale@stocco.it.
- Couleurs RAL ou a échantillon : seulement pour les façades, supplément de €350 prix public
- Sans trou mitigeur sur demande, dans la commande indiquer le code SF.

Meubels en wastafels

- Voor iedere aanpassing moet de uitvoerbaarheid en de prijs ervan bij de commerciële dienst nagevraagd worden op het e-mailadres commerciale@stocco.it.
- Ral-kleuren ofwel per kleurstaal, enkel voor de voorzijden, meerprijs van €350 per meubel
- Op verzoek zonder kraangat, voer de SF-code in de bestelling in.

Base units and washbasins

- For every modification request feasibility and offer to the sales office at the email address commerciale@stocco.it.
- Ral or sample colors: only for the fronts, supplement of €350 list price
- Without mixer-tap hole on request, in the order indicate the code SF.

Iks full Frame : matériaux et finitions

Iks full Frame: materialen en afwerkingen

Iks full: materials and finishes

CAISSON
STRUCTUUR
STRUCTURE

CAT. AF - FENIX
CAT. BF - FENIX COLORATO

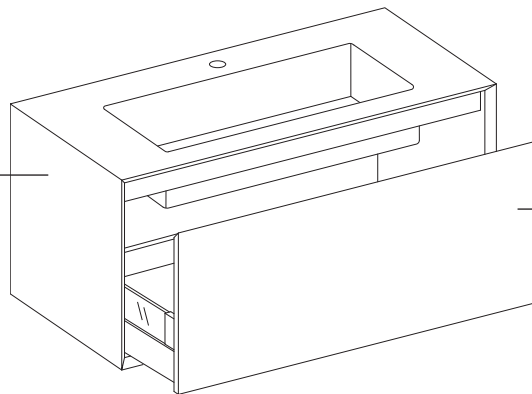

FAÇADE
VOORZIJDEN
FRONT

CAT. O - LACCATO OPACO
CAT. B - LACCATO LUCIDO
CAT. RN - ROVERE NATURALE
CAT. LV2 - ROVERE VINTAGE NERO
CAT. NT - NOCE TAN
CAT. OS - OLMO SMOKE
CAT. W5 - ROVERE TERMO-TRATTATO
CAT. FG - GRES

Attention : le bois est un produit naturel; pourtant ce n'est pas possible de garantir la correspondance aux échantillons. Les variations de la couleur, veines ou effet du bois ne peuvent pas être contestées : elles représentent la valeur du matériel et des travaux artisanales.

Opgepast: hout is een natuurlijk product, om die reden kan het bedrijf niet exact hetzelfde resultaat als dat van de monsters garanderen. Iedere afwijking in kleur, nerven of een ander effect in het hout kan niet het onderwerp van een klacht uitmaken, gezien het een kenmerk is, dat eigen is aan het materiaal en aan de ambachtelijke behandelingen.

Attention: wood is a natural product; therefore the company can not guarantee correspondence with the samples. Any variation of the color, grain or effect of the wood must be considered not contestable, representing the value of the material and of the craftsmanship.

Caisson : matériaux et finitions

Structuur: materialen en afwerkingen

Structure: materials and finishes

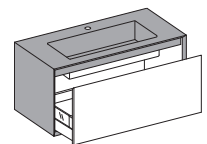

FENIX®

CAT. AF - FENIX

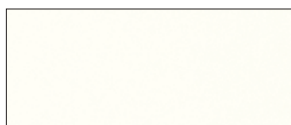

FX32
Bianco Kos

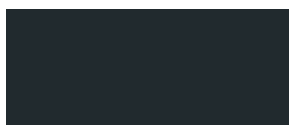

FX720
Nero Ingo

CAT. BF - FENIX COLORATO



FX717
Castoro Ottawa



FX718
Grigio Londra



FX725
Grigio Efeso



FX724
Grigio Bromo



FX751
Rosso Jaipur



* **FX749**
Cacao Orinoco



FX754
Blu Fes

* **FX749**
Cacao Orinoco
Pas disponible
Niet beschikbaar
Unavailable

Façades : matériaux et finitions

Voorzijden: materialen en afwerkingen

Fronts: materials and finishes

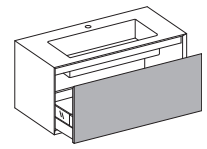

LAQUÉ / GELAKT / LACQUERED

CAT. O - Laqué mat / Mat gelakt / Matt lacquered

CAT. B - Laqué brillant / Glanzend gelakt / Glossy lacquered

PoppingTrend



O. 283 - B. 282
Salice



O. 281 - B. 280
Savana



O. 36 - B. 113
Bordeaux



O. 285 - B. 284
Oriente



O. 287 - B. 286
Oceano



O. 190 - B. 189
Oltremare

FeelingSoft



O. 182 - B. 181
Salvia



O. 271 - B. 270
Tahiti



O. 273 - B. 272
Santorini



O. 275 - B. 274
Lavanda



O. 277 - B. 276
Lilla



O. 279 - B. 278
Pesca

ForeverChic



O. 20 - B. 21
Bianco

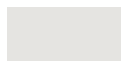

O. 231 - B. 230
Perla



O. 233 - B. 232
Seta

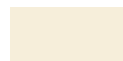

O. 235 - B. 234
Alpaca



O. 172 - B. 171
Lino



O. 180 - B. 179
Avana



O. 237 - B. 236
Argilla



O. 174 - B. 173
Corda



O. 239 - B. 238
Pietra



O. 241 - B. 240
Cervino



O. 243 - B. 242
Dolomiti



O. 245 - B. 244
Arizona



O. 247 - B. 246
Cipria



O. 249 - B. 248
Erica



O. 251 - B. 250
Terra



O. 253 - B. 252
Granata



O. 255 - B. 254
Bosco



O. 257 - B. 256
Oliva



O. 259 - B. 258
Canapa



O. 261 - B. 260
Cotone



O. 263 - B. 262
Efeso



O. 265 - B. 264
Lavaredo



O. 267 - B. 266
Pamir



O. 269 - B. 268
Bromo



O. 198 - B. 104
Grafite



O. 46 - B. 100
Nero

FenixLike



O. 289 - B. 288
Ottawa



O. 291 - B. 290
Londra



O. 263 - B. 262
Efeso



O. 269 - B. 268
Bromo



O. 295 - B. 294
Jaipur



O. 297 - B. 296
Orinoco



O. 293 - B. 292
Fes

BOIS / HOUT / WOOD

Veinage horizontal / Horizontale nerf / Horizontal grain



CAT. RN
Legno Rovere naturale



CAT. LV2
Legno Rovere Vintage
con spacco nero



CAT. W5
Legno Rovere
termo-trattato

Veinage vertical / Verticale nerf / Vertical grain



CAT. OS
Legno Olmo Smoke



CAT. NT
Legno Noce Tan

Façades : matériaux et finitions

Voorzijden: materialen en afwerkingen

Fronts: materials and finishes

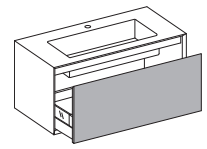

GRES

CAT. FG



Gres mat / Gres mat / Gres matt

FG01
Bianco Statuario Venato
opaco



FG03
Oro Venato opaco



FG05
Nero Marquina opaco



FG07
Noir Desir opaco

Gres brillant / Gres glanzend / Gres glossy

FG02
Bianco Statuario Venato
lucidato

FG04
Oro Venato lucidato

FG06
Nero Marquina lucidato

FG08
Noir Desir lucidato

Iks full Frame : plans vasques

Iks full Frame: wastafelbladen

Iks full: top



Standard: vasque Fenix en matériau composite nanotechnologique, trou pour mitigeur, bonde et couvre-écoulement libre chromés

Non inclus : trop-plein

Standaard: Fenix-wastafel van nanotechnologisch composietmateriaal, mengkraangat, verchromde afvoerplug en afdekop, vrije uitloop

Niet inbegrepen: overloop

Standard: Fenix wash-basin in nanotechnological composite material, mixer-tap hole, free chromed drain and drain cover

Not included: overflow

Disponible dans les versions suivantes :

Verkrijgbaar in de volgende uitvoeringen:

Available in the following versions:

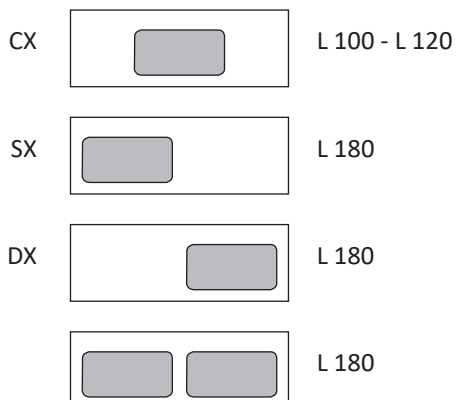
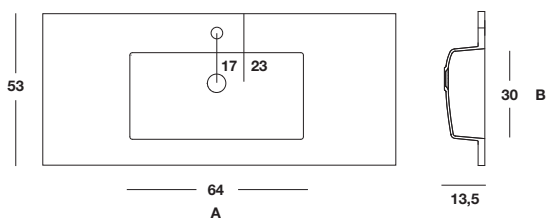
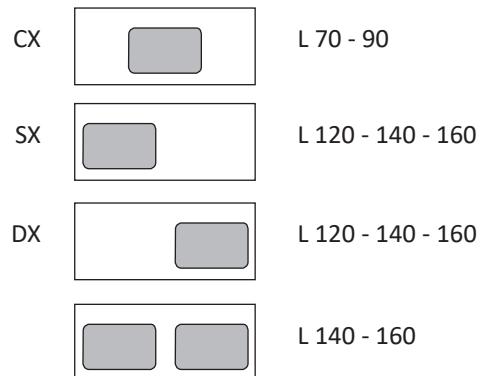
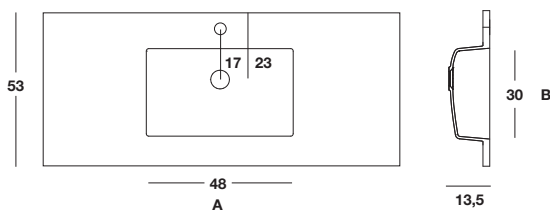

Compatibilité siphon gain de place pour plans vasques moulés

Compatibiliteit compacte sifon voor ingebouwde wastafels
Space-saving siphon compatibility for integrated washbasins

Iks full Frame

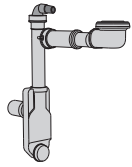

FRAME













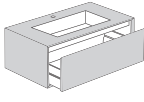
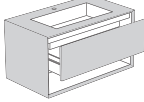
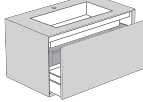
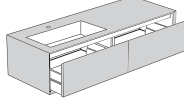
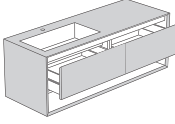
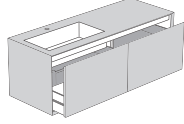



































H.36,5		✓
H.52		✓
H.52		✓

→ 686 **Informations pour la planification**
Informatie voor het ontwerp
Information for planning

Iks full Frame : vue d'ensemble de la collection

Iks full Frame: overzicht produkten

Iks full: product overview

						
	H.36,5	H.52	H.52	H.36,5	H.52	H.52
L.70,5						
L.90,5						
L.100,5						
L.120,5	  	  	  			
L.140				  	  	  
L.160				  	  	  
L.180				  	  	  



Iks meubles

meubles | meubels | base units

P 53 cm



Iks meuble : en détail

Iks meubel: hoe wordt het gemaakt

Iks base unit: how it is made

Iks meuble

Iks meubel

Iks base unit

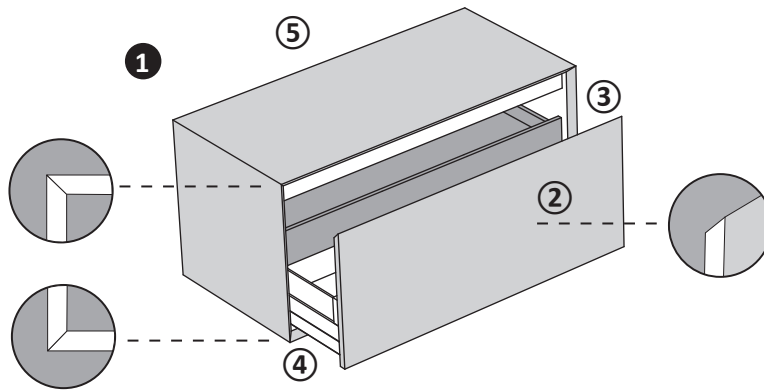

Iks meuble pour vasque à poser

Iks meubel voor opbouwwastafel

Iks base unit for sit-on washbasin

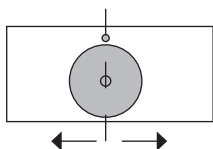
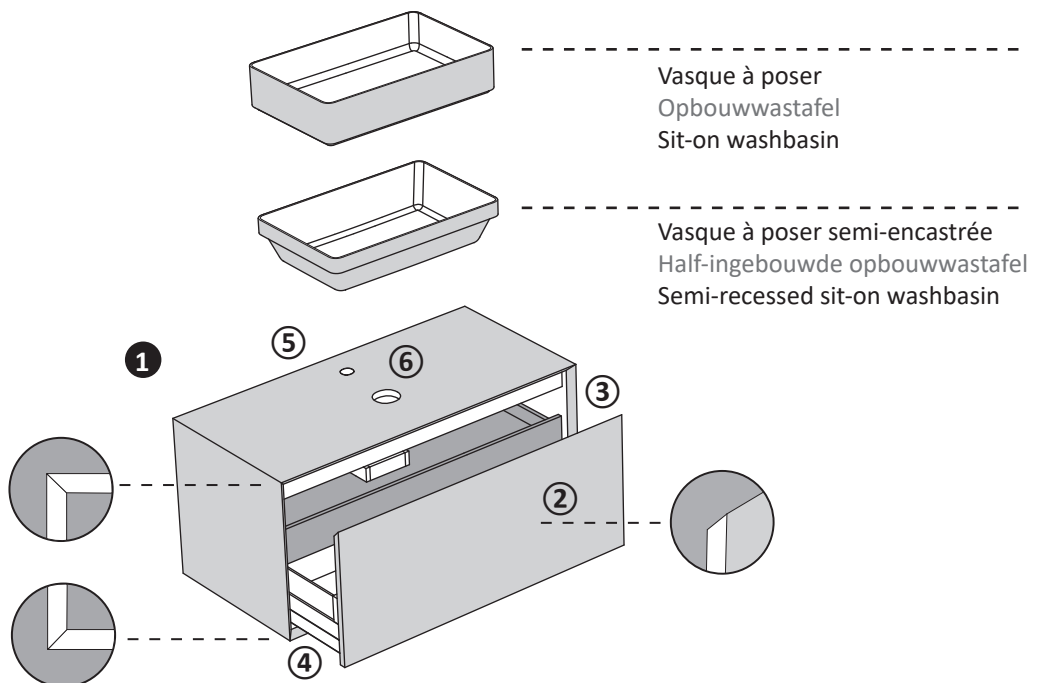

Attention : avec la commande envoyer un dessin technique et indiquer la position de la vasque et du trou mitigeur.

Opgepast: bij de bestelling dient een technische tekening gevoegd te worden die de gekozen wastafel aangeeft, de plaats van de wastafel en van het kraangat.

Attention: to the order enclose a technical drawing indicating the position of the wash-basin and mixer-tap hole.

Iks meuble : en détail

Iks meubel: hoe wordt het gemaakt

Iks base unit: how it is made

① MEUBLE

Réalisé avec différents matériaux, naturels ou technologiques est jointé à 45° sur les 4 coins.

Caisson réalisé avec panneaux de mélamine Classe E1, W100 Fenix®.

② Façades avec ouverture a gorge avec coupe à 45°, en :

- Finitions laquées avec panneau MDF Classe E1

- Finitions bois en placage de bois sur un panneau de contreplaqué de bouleau ou chêne à trois couches

- Finition Grès FG, céramique laminée sur panneau mélaminé Classe E1

③ Caisson interne réalisée avec panneaux de mélamine Classe E1, W100 gris anthracite

④ Tiroirs en métal verni et verre, système de fermeture soft-system

⑤ Installation murale avec supports muraux réglables, barres structurelles en aluminium équipées d'un système anti-dégagement.

① KAST

Van verschillende natuurlijke of technische materialen, 45° verbindingen op de vier hoeken.

Structuur van panelen met melaminelaag klasse E1, W100 Fenix®.

② Frontelementen met verzonken 45° profielgreep:

- Gelakte afwerkingen met MDF-paneel klasse E1

- Houtfineer op berken multiplex of eiken triplex

- Afwerking FG-grès, keramisch laminaat op MDF-paneel klasse E1

③ Inwendige structuur van panelen met melaminelaag klasse E1, antracietgrijs W100

④ Gelakte laden van metaal en glas, met zachteluiting

⑤ Bevestiging aan de wand met verstelbaar wandbeslag en aluminium wandrails met kantelbeveiliging.

① BASE UNIT

Made of different materials, natural or technological, it is jointed at 45° on the four corners.

Structure made of melamine Class E1, W100 Fenix® panels.

② Fronts with shaped groove opening with 45° cut, made of:

- Lacquered finishes with MDF panel Class E1

- Wood finishes, wood veneer on a multilayered birchwood panel or three-layer oak

- Finish Gres FG, laminated ceramic on melamine panel Class E1

③ Internal structure made with melamine panels Class E1, W100 anthracite gray

④ Drawers in painted metal and glass, soft-closing system

⑤ Wall installation with adjustable wall brackets, structural bars in aluminium equipped with an anti-release system.

Réalisations sur mesure

Op maat gemaakte bewerkingen

Made-to-measure

Meubles

- Pour toute modification demander la faisabilité et les devis au bureau commercial à l'adresse email commerciale@stocco.it.

- Couleurs RAL ou a échantillon : seulement pour les façades, supplément de €350 prix public

Meubels

- Voor iedere aanpassing moet de uitvoerbaarheid en de prijs ervan bij de commerciële dienst nagevraagd worden op het e-mailadres commerciale@stocco.it.

- Ral-kleuren ofwel per kleurstaal, enkel voor de voorzijden, meerprijs van €350 per meubel

Base units

- For every modification request feasibility and offer to the sales office at the email address commerciale@stocco.it.

- Ral or sample colors: only for the fronts, supplement of €350 list price

Iks meuble : matériaux et finitions

Iks meubel: materialen en afwerkingen

Iks base unit: materials and finishes

CAISSON
STRUCTUUR
STRUCTURE

CAT. AF - FENIX
CAT. BF - FENIX COLORATO

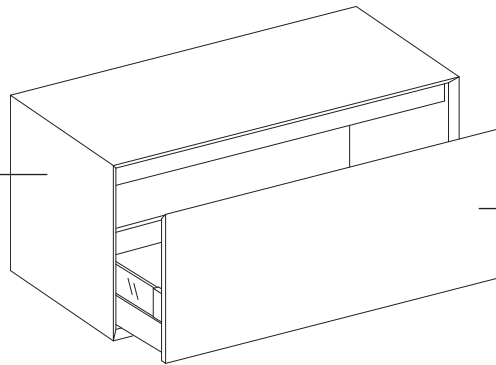

FAÇADE
VOORZIJDEN
FRONT

CAT. RN - ROVERE NATURALE
CAT. LV2 - ROVERE VINTAGE SPACCO NERO
CAT. W5 - ROVERE TERMO-TRATTATO
CAT. NT - NOCE TAN
CAT. OS - OLMO SMOKE
CAT. O - LACCATO OPACO
CAT. B - LACCATO LUCIDO
CAT. FG - GRES

Attention : le bois est un produit naturel; pourtant ce n'est pas possible de garantir la correspondance aux échantillons. Les variations de la couleur, veines ou effet du bois ne peuvent pas être contestées : elles représentent la valeur du matériel et des travaux artisanales.

Opgepast: hout is een natuurlijk product, om die reden kan het bedrijf niet exact hetzelfde resultaat als dat van de monsters garanderen. Iedere afwijking in kleur, nerven of een ander effect in het hout kan niet het onderwerp van een klacht uitmaken, gezien het een kenmerk is, dat eigen is aan het materiaal en aan de ambachtelijke behandelingen.

Attention: wood is a natural product; therefore the company can not guarantee correspondence with the samples. Any variation of the color, grain or effect of the wood must be considered not contestable, representing the value of the material and of the craftsmanship.

Caisson : matériaux et finitions

Structuur: materialen en afwerkingen

Structure: materials and finishes

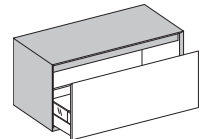

FENIX®

CAT. AF - FENIX

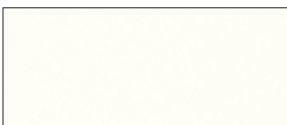

FX32
Bianco Kos



FX720
Nero Ingo

CAT. BF - FENIX COLORATO



FX717
Castoro Ottawa



FX718
Grigio Londra



FX725
Grigio Efeso



FX724
Grigio Bromo



FX751
Rosso Jaipur



FX749
Cacao Orinoco



FX754
Blu Fes

Façades : matériaux et finitions

Voorzijden: materialen en afwerkingen

Fronts: materials and finishes

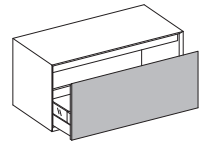

LAQUÉ / GELAKT / LACQUERED

CAT. O - Laqué mat / Mat gelakt / Matt lacquered

CAT. B - Laqué brillant / Glanzend gelakt / Glossy lacquered

PoppingTrend



O. 283 - B. 282
Salice



O. 281 - B. 280
Savana



O. 36 - B. 113
Bordeaux



O. 285 - B. 284
Oriente



O. 287 - B. 286
Oceano



O. 190 - B. 189
Oltremare

FeelingSoft



O. 182 - B. 181
Salvia



O. 271 - B. 270
Tahiti



O. 273 - B. 272
Santorini



O. 275 - B. 274
Lavanda



O. 277 - B. 276
Lilla



O. 279 - B. 278
Pesca

ForeverChic



O. 20 - B. 21
Bianco

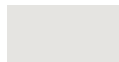

O. 231 - B. 230
Perla



O. 233 - B. 232
Seta

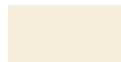

O. 235 - B. 234
Alpaca



O. 172 - B. 171
Lino



O. 180 - B. 179
Avana



O. 237 - B. 236
Argilla



O. 174 - B. 173
Corda



O. 239 - B. 238
Pietra



O. 241 - B. 240
Cervino



O. 243 - B. 242
Dolomiti



O. 245 - B. 244
Arizona



O. 247 - B. 246
Cipria



O. 249 - B. 248
Erica



O. 251 - B. 250
Terra



O. 253 - B. 252
Granata



O. 255 - B. 254
Bosco



O. 257 - B. 256
Oliva



O. 259 - B. 258
Canapa



O. 261 - B. 260
Cotone



O. 263 - B. 262
Efeso



O. 265 - B. 264
Lavaredo



O. 267 - B. 266
Pamir



O. 269 - B. 268
Bromo



O. 198 - B. 104
Grafite



O. 46 - B. 100
Nero

FenixLike



O. 289 - B. 288
Ottawa



O. 291 - B. 290
Londra



O. 263 - B. 262
Efeso



O. 269 - B. 268
Bromo



O. 295 - B. 294
Jaipur



O. 297 - B. 296
Orinoco



O. 293 - B. 292
Fes

BOIS / HOUT / WOOD

Veinage horizontal / Horizontale nerf / Horizontal grain



CAT. RN
Legno Rovere naturale



CAT. LV2
Legno Rovere Vintage
con spacco nero



CAT. W5
Legno Rovere
termo-trattato

Veinage vertical / Verticale nerf / Vertical grain



CAT. OS
Legno Olmo Smoke



CAT. NT
Legno Noce Tan

Façades : matériaux et finitions

Voorzijden: materialen en afwerkingen

Fronts: materials and finishes

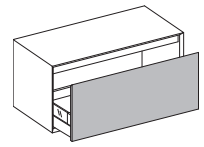

GRES

CAT. FG



Gres mat / Gres mat / Gres matt

FG01

Bianco Statuario Venato
opaco



FG03

Oro Venato opaco



FG05

Nero Marquina opaco

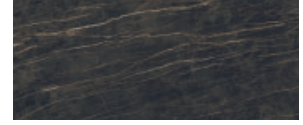

FG07

Noir Desir opaco

Gres brillant / Gres glanzend / Gres glossy

FG02

Bianco Statuario Venato
lucidato

FG04

Oro Venato lucidato

FG06

Nero Marquina lucidato

FG08

Noir Desir lucidato

Iks meuble : vue d'ensemble de la collection

Iks meubel: overzicht produkten

Iks base unit: product overview

Iks meuble

Iks meubel

Iks base unit

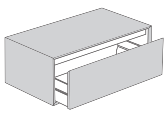
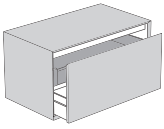
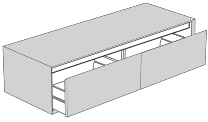
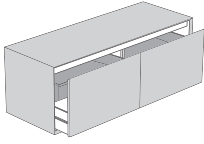









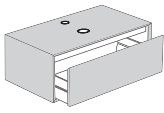
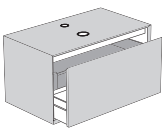
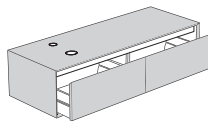
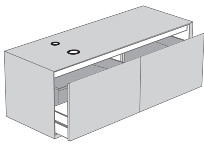



				
	H.36,5	H.52	H.36,5	H.52
L.70,5	●	●		
L.90,5	●	●		
L.100,5	●	●		
L.120,5	●	●		
L.140			●	●
L.160			●	●
L.180			●	●

● Disponible | Beschikbaar | Available

Iks meuble pour vasque à poser

Iks meubel voor opbouw wastafel

Iks base unit for sit-on washbasin

				
	H.36,5	H.52	H.36,5	H.52
L.70,5				
L.90,5				
L.100,5				
L.120,5				
L.140				
L.160				
L.180				

Couleurs laqués

Gelakte kleuren

Lacquered colours

Fruit d'une constante recherche sur les couleurs, inspiré par les tendances les plus actuelles de l'ameublement, de la mode et du design, la palette offre un large choix de couleurs et de finitions. Les panneaux frontaux sont réalisés en MDF polyester et poli, indice de qualité et de soin supérieure dans le choix des matériaux les plus adaptés au vernissage supérieure. Le vernis mat, grâce à l'emploi de vernis aux microsphères céramiques, en augmente la résistance. Pour le vernissage brillant, on emploie des vernis polyuréthanes et les parties courbes sont immédiatement pulvérisées à la main par des artisans expérimentés. Les couleurs métallisées sont réalisées par l'adjonction aux vernis de poudres de métal. Pour tous les composants vernis, on applique enfin des contrôles rigoureux de qualité, en contrôlant chaque pièce afin de garantir une qualité et une précision maximales.

Entretien et nettoyage

Nettoyer avec un chiffon doux ou une éponge non abrasive humide et des détergents neutres non abrasifs. Bien rincer la surface après le nettoyage. Ne pas utiliser de solvants chimiques agressifs comme l'acétone, le trichloréthylène, les solvants. En cas de taches rebelles, et uniquement sur les surfaces laquées brillantes, utiliser un chiffon doux imbibé de produit pour le lavage des vitres ou un savon neutre. Ne pas utiliser ammoniaque. Il est conseillé d'essayer tout produit sur la partie interne de la surface, ou dans un angle, avant de l'utiliser sur la partie externe. Bien sécher la surface après l'usage.

Het pallet, het resultaat van een niet aflatende zoektocht naar kleur, geïnspireerd op de nieuwste tendenzen op het vlak van inrichting, mode en design, biedt een ruim gamma aan kleuren en afwerkingen. De voorkanten zijn uitgevoerd in gepolijst MDF met polyester, wat kenmerkend is voor de hoge kwaliteit en de zorg waarmee de meest geschikte materialen voor een hoogwaardige laklaag uitgekozen worden. Voor de glanzende laklaag worden polyuretaan-lakken gebruikt, en de gebogen delen worden zelfs manueel gelakt door ervaren ambachtslui. De gemetalliseerde gelakte kleuren worden verkregen door echt metaalstof aan de vernissen toe te voegen. Tenslotte worden alle gelakte onderdelen aan zeer strenge kwaliteitscontroles onderworpen - ieder stuk wordt afzonderlijk gecontroleerd om een maximum aan kwaliteit en precisie te garanderen.

Onderhoud en schoonmaak

Schoonmaken met een vochtige, niet-schurende doek of spons met neutrale, niet-schurende poetsmiddelen. Na het schoonmaken de oppervlakte goed naspoelen. Geen agressieve chemische solventen gebruiken zoals aceton, trichloorethyleen en solventen. Enkel op de glanzend gelakte oppervlakten kan er voor hardnekkige vlekken een zachte doek gebruikt worden met neutrale zeep of een produkt voor glazen oppervlakten. Het is aangeraden ieder produkt eerst te testen op een niet-zichtbare plek. Na gebruik de oppervlakten grondig drogen.

The range offers a variety of colours and finishings, thanks to continuous research into colour, inspired and influenced by the latest trends in terms of furniture, fashion and design. The fronts are in polished polyester MDF, following high quality and care in the choice of the most suitable materials for excellent lacquering. The lacquering in an opaque finish, thanks to the use of varnishes with ceramic micro spheres, adds to its resistance. For the gloss lacquering, polyurethane varnishes are used and the curved parts are even hand-brushed by skilled craftsmen and women. The lacquered metallised colours are made by adding metal powder to the coatings. For all the lacquered components, we perform strict quality checks, inspecting every single piece to ensure the highest quality and precision.

Maintenance and cleaning

Clean with a soft cloth or humid non-abrasive sponge using neutral and non-abrasive detergents. Rinse the surface carefully after cleaning. Do not use aggressive chemical solvents, such as acetone and trichloroethylene. In case of persistent stains, use a soft cloth with neutral soap or products suitable for cleaning windows (only on glossy lacquered surfaces). Do not use ammonia. We recommend testing any product on the internal side of the surface, e.g. in a corner, before using it on the outer surface. Accurately dry the surfaces after use.



Hygiénique
Hygiënisch
Hygienic



Facile à nettoyer
Gemakkelijk schoon te maken
Easy to clean

Bois

Hout
Wood

La proposition de bois est conçu pour ceux qui préfèrent un matériau avec un charme naturel. Elle présente un large choix de finitions en bois plaqué pour consoles, meubles et façades, traités pour une utilisation dans la salle de bain.

Le rouvre et le Walnut naturel (noyer américain) sont vernis à l'acrylique transparent.

Le Rovere Safari est teint et vernis en acrylique transparent.

Le Rovere Vintage et le Rovere termotrattato sont obtenus à partir de parties "briccola" très nouvelles et présentent des couleurs variées en raison de l'exposition aux agents atmosphériques. Ils présentent des fissures et des nœuds ouverts en forme d'étoile. Le vernis du Rovere Vintage est complété d'une sous-couche noire ou claire pour mettre en évidence la finition irrégulière.

Le bois thermotraité est tri-couche traité à haute température et verni à l'acrylique transparent avec des fentes partiellement remplies de noir ou blanches.

Le placage du Rovere Termocotto est traité à haute température et peint en acrylique transparent.

Le Noce Tan a une couleur naturelle avec des effets de clair-obscur marqués, il est peint en acrylique transparent, avec un léger brossage. L'Olmo Smoke est naturellement noirci avec un traitement de fumage en autoclave, peint en acrylique transparent et brossé.

Les bois sélectionnés

Le bois est un matériau qui a son unicité et son originalité. En raison de cette caractéristique, on peut trouver des différences dans les tons de grain et de couleur qui tombent dans les tolérances fixées par les normes.

Ons assortiment met hout is bedoeld voor wie materiaal met een natuurlijke uitstraling verkiest. Er is een ruime keuze aan houtfineer voor wastafelbladen, planken, kasten en frontelementen die speciaal behandeld zijn voor gebruik in badkamers.

Natuurlijk eikenhout (Rovere naturale) en natuurlijk (Amerikaans) walnoothout (WALnut), afgelakt met transparante acryllak.

Safari eikenhout (Rovere Safari) is gekleurd en afgelakt met transparante acryllak.

Vintage eikenhout (Rovere Vintage) en thermisch behandeld eikenhout zijn gemaakt van de kern van Venetiaans meerpalenhout (briccola) of noestig hout met een kenmerkende variëteit aan kleuren door blootstelling aan weer en wind. Dit hout heeft gebarsten nerven en open noesten, ook stervormige.

Houtfineer van Rovere Vintage is aangebracht op een zwarte ondergrond om het natuurlijke aspect van spleethout te benadrukken. Thermisch behandeld eikenhout bestaat uit drie lagen en is met warmte behandeld, gebleekt of afgelakt met transparante acryllak met gedeeltelijk zwart afgekitte spleten.

Ons houtfineer van met warmte behandeld eikenhout (Rovere Termocotto) is afgelakt met transparante acryllak.

Notenhout Tan (Noce Tan) heeft een natuurlijke kleur met mooie licht-donker effecten, is afgelakt met transparante acryllak en lichtjes geborsteld.

Olmhout Smoke (Olmo Smoke) is natuurlijk gerookt en verdonkerd in rookkamer, afgelakt met transparante acryllak en geborsteld.

Onze houtsoorten

Hout is een materiaal met unieke en originele eigenschappen. Daarom kunnen er verschillen zijn in nervenpatronen en kleuren die binnen de standaard vallende tolerantiewaarden vallen.

The proposal of woods is designed for those who prefer a material with a natural charm. It presents a wide choice of veneered wood finishes for top shelves, furniture and fronts, treated for use in the bathroom. Natural oak and Walnut are painted with transparent acrylic.

The Rovere Safari is dyed and painted in transparent acrylic.

Vintage and thermotreated oak are obtained from "briccola" interiors or gnarled plants featuring different colours due to the exposure to atmospheric agents. It also features medullary cracks and star-shaped open gnarls. The veneer of the Vintage oak is completed with black or light support to highlight the split finish. The heat-treated wood, is a tri-layer, teated at high temperatures and painted with transparent acrylic with splits partially filled in black or bleached.

The Veneer of the Termocotto Oak is treated at high temperatures and painted in transparent acrylic.

The Noce Tan has a natural color with marked chiaroscuro effects, it is painted in transparent acrylic, with light brushing.

The Olmo Smoke is naturally darkened with an autoclave smoking treatment, painted in transparent acrylic and brushed.

The woods selected

Wood is a material that has its uniqueness and originality. Due to this characteristic, differences in grain and color tones can be found, that fall within the tolerances set by the standards.

Bois

Hout
Wood

Entretien et nettoyage

Nettoyer avec un chiffon doux ou une éponge non abrasive humide et des détergents neutres non abrasifs. Bien rincer la surface après le nettoyage. Ne pas utiliser de solvants chimiques agressifs comme l'acétone, le trichloréthylène, les solvants. En cas de taches rebelles, utiliser un chiffon doux imbibé de savon neutre. Il est conseillé d'essayer tout produit sur la partie interne de la surface, ou dans un angle, avant de l'utiliser sur la partie externe. Bien sécher la surface après l'usage.

Onderhoud en schoonmaak

Schoonmaken met een vochtige, niet-schurende doek of spons met neutrale, niet-schurende poetsmiddelen. Na het schoonmaken de oppervlakte goed naspoelen. Geen agressieve chemische solventen gebruiken zoals aceton, trichloorethyleen en solventen. Voor hardnekkige vlekken kan een zachte doek gebruikt worden met neutrale zeep. Het is aangeraden ieder produkt eerst te testen op een niet-zichtbare plek. Na gebruik de oppervlakten grondig drogen.

Maintenance and cleaning

Clean with a soft cloth or humid non-abrasive sponge using neutral and non-abrasive detergents. Rinse the surface carefully after cleaning. Do not use aggressive chemical solvents, such as acetone and trichloroethylene. In case of persistent stains, use a soft cloth and neutral soap. We recommend testing any product on the internal side of the surface, e.g. in a corner, before using it on the outer surface. Accurately dry the surfaces after use.



Vrai bois plaqué
Fineerpaneel van echt hout
Real wood veneer



Facile à nettoyer
Gemakkelijk schoon te maken
Easy to clean

Gres

Le gres est une céramique porcelainée ultra-mince de qualité supérieure, de conception nouvelle dont les points forts sont l'adaptabilité et la facilité d'emploi. Il est résistant tout en étant léger, plat mais souple et facile à désinfecter, totalement écologique et à même d'atteindre l'excellence des carreaux de grès céramique.

Entretien et nettoyage

Nettoyer avec un chiffon ou une éponge humide et des détergents neutres non abrasifs, dilués dans l'eau chaude. Bien rincer la surface après le nettoyage. Ne pas utiliser de solvants chimiques agressifs.

Gres is ultradun porseleinkeramiek van superieure kwaliteit, een nieuw concept met als bijzondere kenmerken veelzijdigheid en gebruiksgemak. Het is zeer resistent maar toch licht, vlak maar tegelijk flexibel, gemakkelijk schoon te maken en volledig ecologisch; dit materiaal tilt de kwaliteit van keramische tegels naar een hoger niveau.

Onderhoud en schoonmaak

Schoonmaken met een vochtige doek of spons, met neutrale, niet-schurende poetsmiddelen, verdund in warm water. Na het schoonmaken de oppervlakte goed naspoelen. Geen agressieve chemische solventen gebruiken zoals aceton, trichloorethyleen en solventen.

Gres is a high-quality, very fine ceramic porcelain. Its a new concept, extremely versatile and easy to work. It is resistant but light, flat but flexible. It can be cleaned easily, it is completely environmentally friendly and is used to make excellent quality porcelain stoneware.

Maintenance and cleaning

Clean with a cloth or humid sponge using neutral and non-abrasive detergents diluted in hot water. Rinse the surface carefully after cleaning. Do not use aggressive chemical solvents.



Hygiénique
Hygiënisch
Hygienic



Facile à nettoyer
Gemakkelijk schoon te maken
Easy to clean



Résistant aux éraflures
Krasbestendig
Scratch-resistant

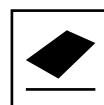

Planar et mince
Vlak en dun
Flat and thin

Matériau innovant créé pour le design intérieur. La partie extérieure de FENIX NTM® est obtenue à l'aide de nanotechnologies et caractérisée par une surface décorative traitée par des résines thermoplastiques de nouvelle génération qui la rend extrêmement mate, en limitant la réflexion de la lumière, anti-abrasion, douce au toucher et permettant la réparation thermique des micro-éraflures. En outre, FENIX NTM® est un matériau résistant aux éraflures, au frottement, à l'abrasion et au choc, avec une capacité élevée d'élimination des bactéries, hygiénique, facile à nettoyer, anti-moisissure, antistatique, hydrofuge et résistant à la chaleur sèche.

Entretien et nettoyage

Nettoyer avec un chiffon doux ou une éponge non abrasive humide et des détergents neutres non abrasifs. Bien rincer la surface après le nettoyage. Ne pas utiliser de solvants chimiques agressifs comme l'acétone, le trichloréthylène, les solvants et les produits à base de cire, blanchissants ou chlorés. Utiliser de l'alcool ou de l'acétone et un chiffon doux pour retirer les taches rebelles.

Een vernieuwend materiaal, speciaal gecreëerd voor de binnenhuisinrichting. De buitenkant van FENIX NTM® wordt gemaakt met behulp van nanotechnologieën en wordt gekenmerkt door een gedecoreerd oppervlak, dat behandeld is met de nieuwste generatie thermoplastische harsen die de oppervlakte zeer mat maken, met een beperkte lichtweerskaatsing, zodat het bestand is tegen vingerafdrukken, zacht aanvoelt en de mogelijkheid biedt kleine krassen via verhitting weg te werken. Bovendien is FENIX NTM® een krasbestendig materiaal, dat tegen wrijving kan, stootvast is en een grote antibacteriële werking heeft, hygiënisch is, gemakkelijk in onderhoud, anti-schimmel, anti-statisch, waterafstotend, en dat bestand is tegen droge hitte.

Onderhoud en schoonmaak

Schoonmaken met een vochtige, niet-schurende doek of spons met neutrale, niet-schurende poetsmiddelen. Na het schoonmaken de oppervlakte goed naspoelen. Geen agressieve chemische solventen gebruiken zoals trichloorethyleen, solventen en producten die was, bleekmiddel of chloor bevatten. Voor hardnekkige vlekken alcohol of aceton op een zachte doek gebruiken.

Cutting-edge material created for interior design. The outer part of FENIX NTM® is obtained from nanotechnologies and features a decorated surface treated with new generation thermoplastic resins which make the surface highly opaque, with low light reflection, resistant to fingerprints, soft to the touch and which allow micro scratches to be removed thermally. Moreover, FENIX NTM® is a material which resists scratches, rubbing, abrasion and blows. It actively impedes bacteria, is hygienic, easy to polish, anti-mould, anti-static, water-repellent and resistant to dry heat.

Maintenance and cleaning

Clean with a soft cloth or humid non-abrasive sponge using neutral and non-abrasive detergents. Rinse the surface carefully after cleaning. Do not use aggressive chemical solvents, such as, trichloroethylene, solvents, wax, bleach or chlorine. Use a soft cloth dampened in alcohol or acetone to remove stubborn stains.



Certificat pour les panneaux en mélaminé et MDF garantissant l'emploi de panneaux à émission de formaldéhyde inférieure au minimum imposé par la norme européenne UNI EN13896.

Certificaat voor panelen in melamine en MDF ter garantie dat er panelen gebruikt worden met een formaldehyde uitstoot die lager ligt dan het wettelijk minimum van de Europese norm UNI EN13896.

Certificate for melamine and MDF panels that guarantees the use of panels with formaldehyde emissions lower than the minimum required by the European standard UNI EN13896.



Certificat de traitement du panneau à la résine hydrofuge.

Certificaat dat de panelen met waterafstotende harsen behandeld werden.

Certificate of treatment of panels with water-repellent resins.



Surface extrêmement mate, faible réflectivité
Zeer mat oppervlak, lage lichtweerskaatsing
Extremely matt surface, low light reflectivity



Résistant aux éraflures
Krasbestendig
Scratch-resistant



Aucune trace de doigts
Anti vingerafdrukken
Anti-fingerprint

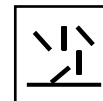

Résistant aux moisissures
Anti schimmel
Mold-resistant



Hygiénique
Hygiënisch
Hygienic



Facile à nettoyer
Gemakkelijk schoon te maken
Easy to clean